

* REVISIONS				
LTR	DESCRIPTION	DATE	REVISED	APPROVED

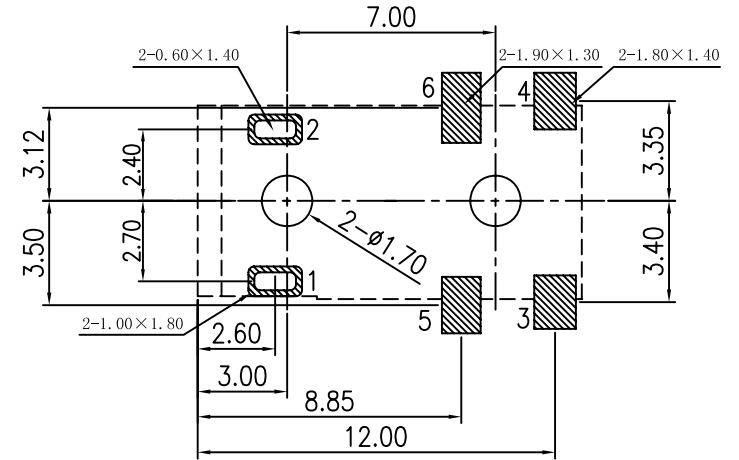

T:1.0 Dimensions of PC board holes
Tolerance : ±0.05(Printed-top view)

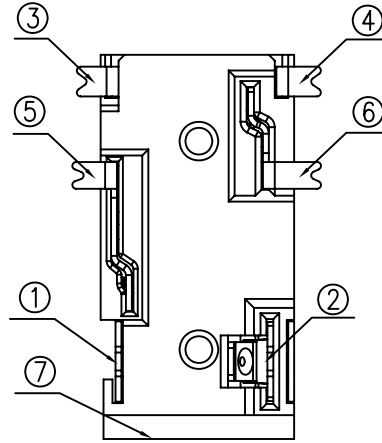
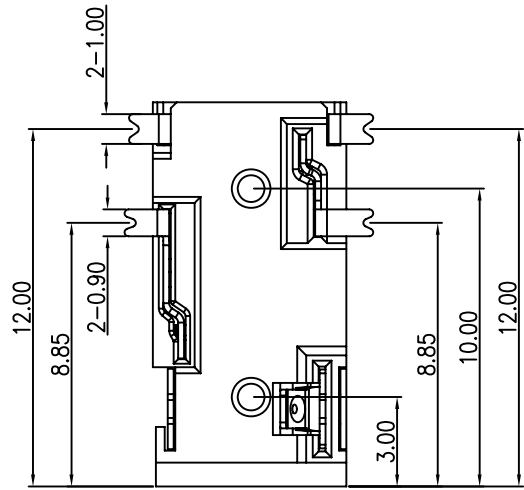
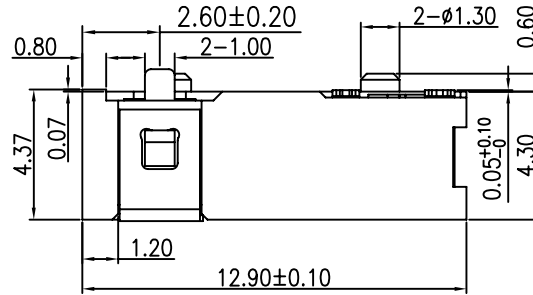
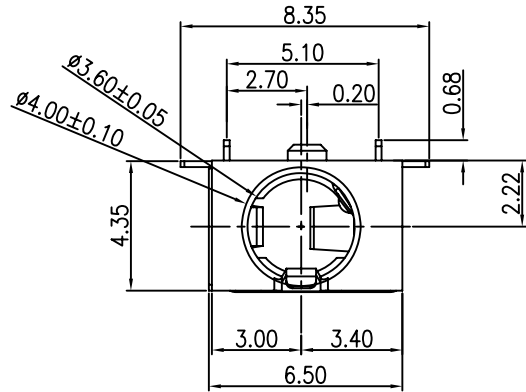

LEAD FREE

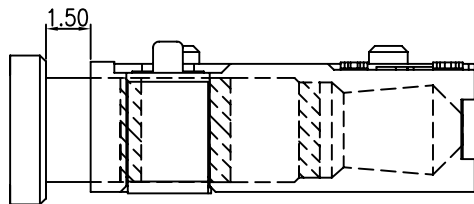
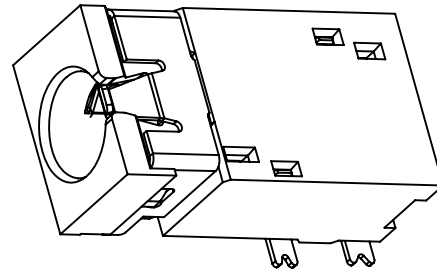
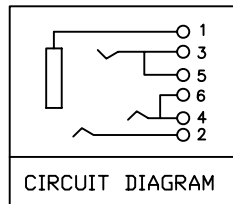

UNLESS OTHERWISE SPECIFIED, TOLERANCE ON DECIMAL: ±0.2

7	HOUSING	1	PA10T		UL-94V0(BLACK)
6	TERMINAL 6#	1	C5191	t=0.2	Au PLATED
5	TERMINAL 5#	1	C5191	t=0.2	Au PLATED
4	TERMINAL 4#	1	C5191	t=0.2	Au PLATED
3	TERMINAL 3#	1	C5191	t=0.2	Au PLATED
2	TERMINAL 2#	1	C5191	t=0.2	Au PLATED
1	TERMINAL 1#	1	C5191	t=0.2	Au PLATED
LTR	PART NAME	QTY	MATERIAL		REMARK
DWN	LILY	DATE	2016.01.23	3RD ANGLE PROJECTION	NAME MINIATURE JACK
CHKD	ANDY	DATE	2016.01.23		
APVD	JON	DATE	2016.01.23	UNIT: mm	CAT. NO. PJS-035-66AG
JKCR Electronics Co., Ltd.					DWN.NO. A-035-65
					001